

EVERYCOM X8 PROJECTOR USER MANUAL

Please read manual throughly before using and keep it for future reference.

CONTENTS

Packing Content	01
Function Overview	02
Remote Overview	03
Input Source	04
Quick Start	05
Projector Connection	06
Projection Distance & Size	06
Specifications	07
Troubleshooting Guide	08

PACKING CONTENT

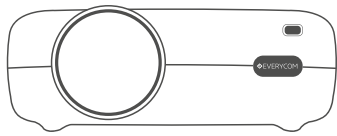

Projector



Remote

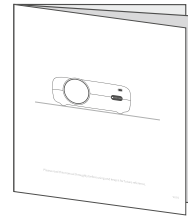

User Manual

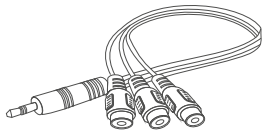

AV Cable

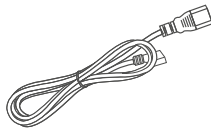

Power Cable

NOTICE

Recommended

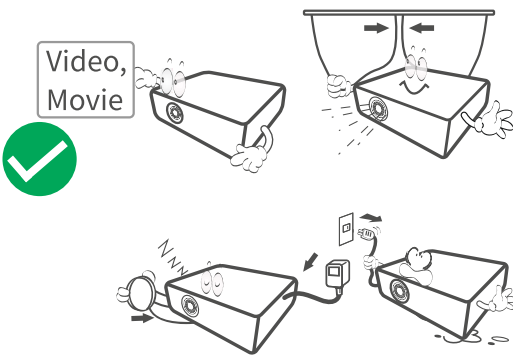

Not Recommended

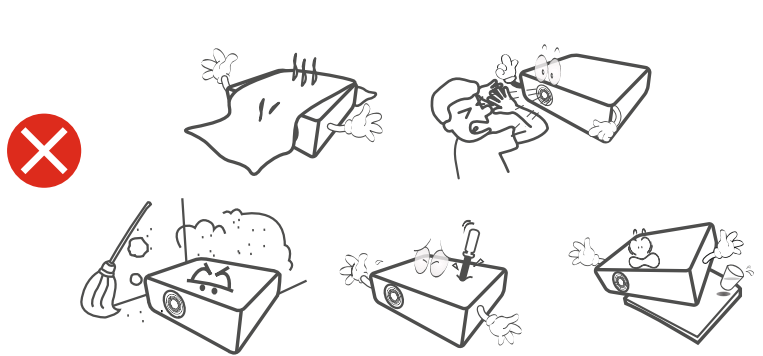

FUNCTION OVERVIEW

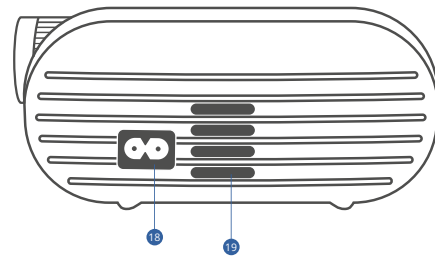
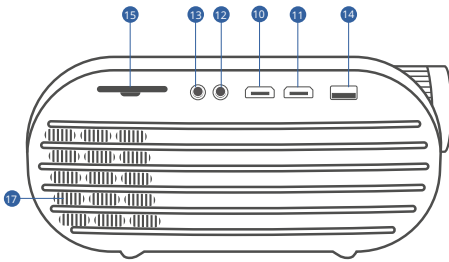
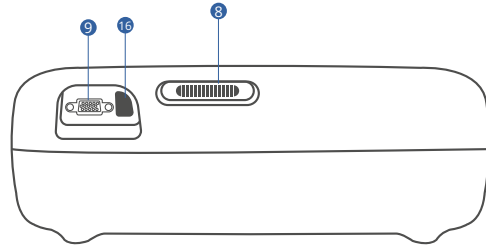
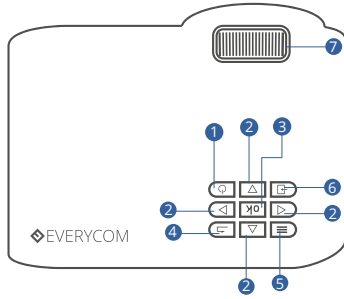

Serial Number	Define	Describe
1	on/off	on/off
2	up and down, Left and Right	multi-function up and down, left and right
3	ok	function to confirm
4	return	function to return
5	menu	menu display
6	Signal source	source display
7	focusing ring	resolution adjustment
8	Keystone Correction	± 15 adjustment picture keystone out alignment
9	VGA/Computer	Computer input or other VGA output devices
10-11	HDMI	connect HDMI input or other HDMI output device
12	Compound video input interface	3-in-1 switching line access composite video signal
13	3.5mm headphone jack	headphone jack or active speaker jack
14	the USB interface	Connect the USB disk or move the hard disk/mouse
15	SD card	SD card slot
16	IR force control head	remote reception signal
17	Speaker	Built In Speaker
18	Power input	For main power connection
19	Air outlet	For perfect airflow inside projector

REMOTE OVERVIEW

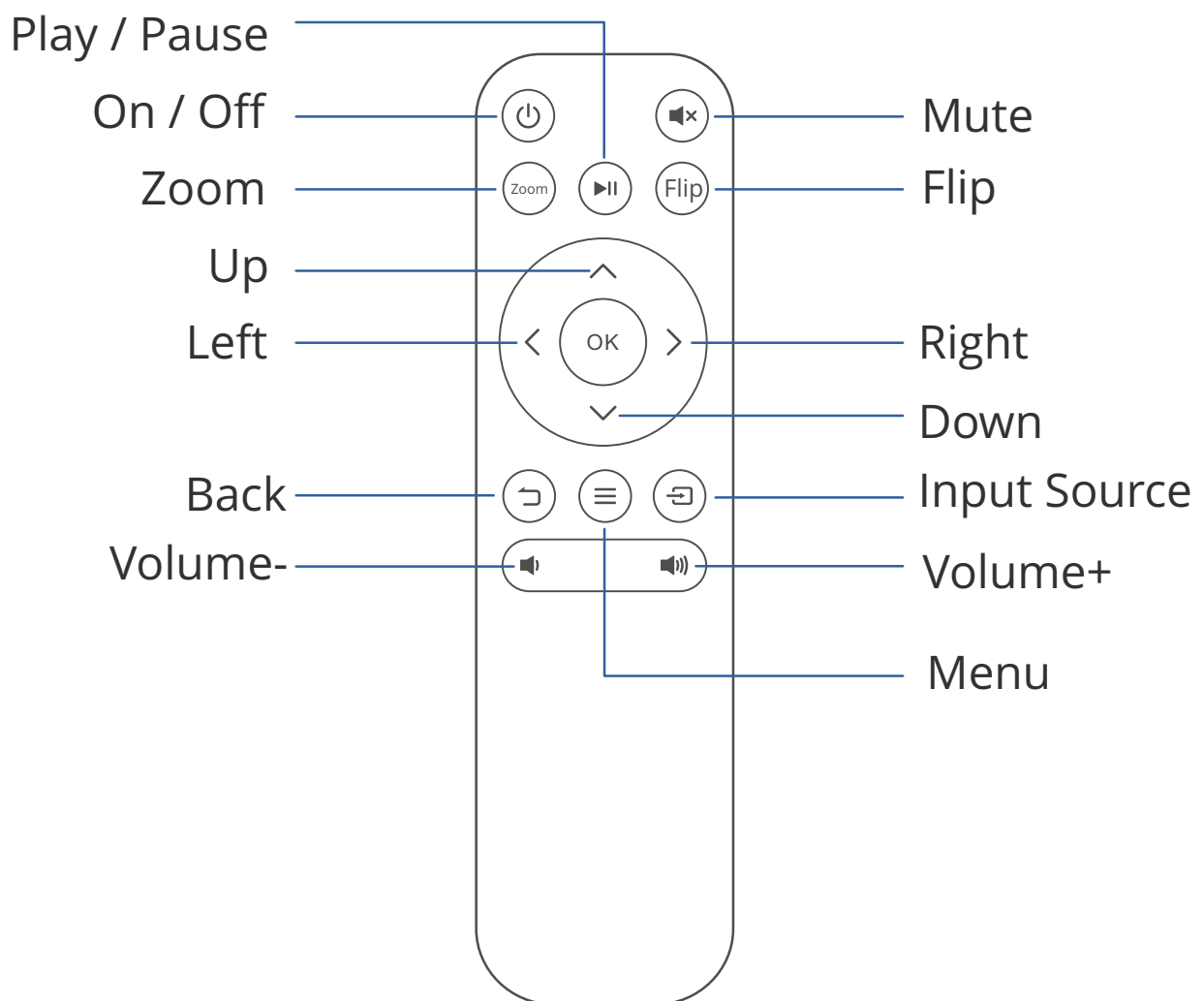

INPUT SOURCE

Press  button on the projector or remote to enter the interface of INPUT SOURCE.

A. VGA Connection

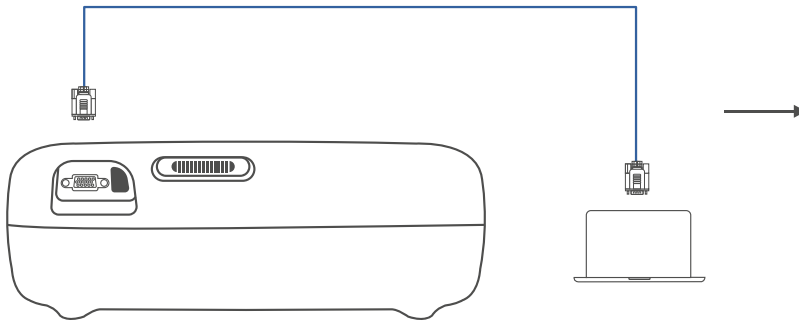

Input Source
AV
VGA
HDMI 1
HDMI 2
USB/SD
OK

B. USB Connection

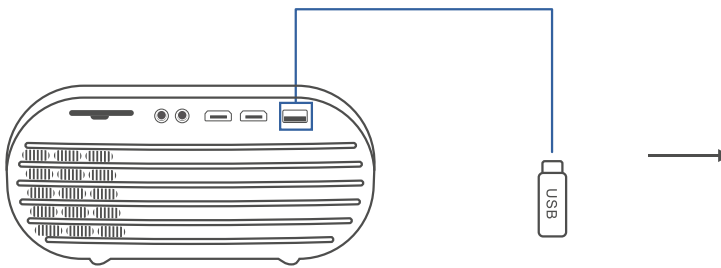

Input Source
AV
VGA
HDMI 1
HDMI 2
USB/SD
OK

C. HDMI Connection

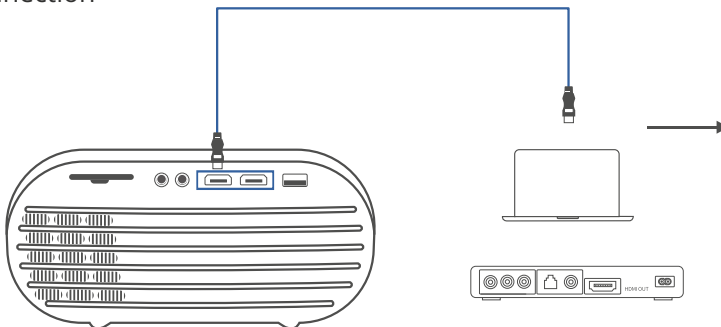

Input Source
AV
VGA
HDMI 1
HDMI 2
USB/SD
OK

QUICK START

1. START AND CLOSE

* Connect the projector to the DC side of the power adapter, then turn on the power supply of the adapter, the power indicator light of the body will be on, and the projector will enter the standby state.

* Start: press the "on/off" button on the projector body or the remote control

2. IMAGE FOCUSING

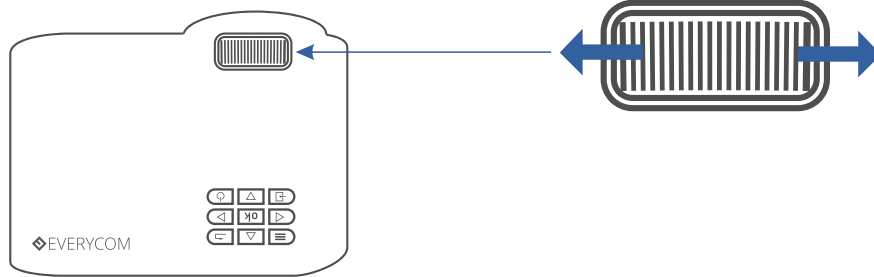

3. KEYSTONE CORRECTION

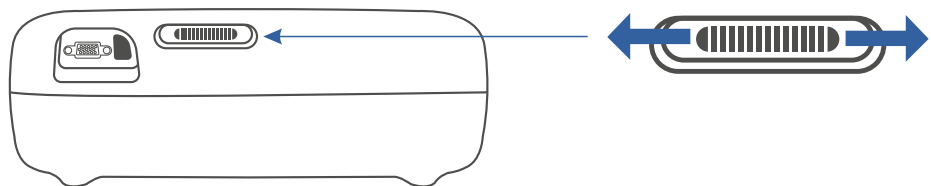

PROJECTOR CONNECTION

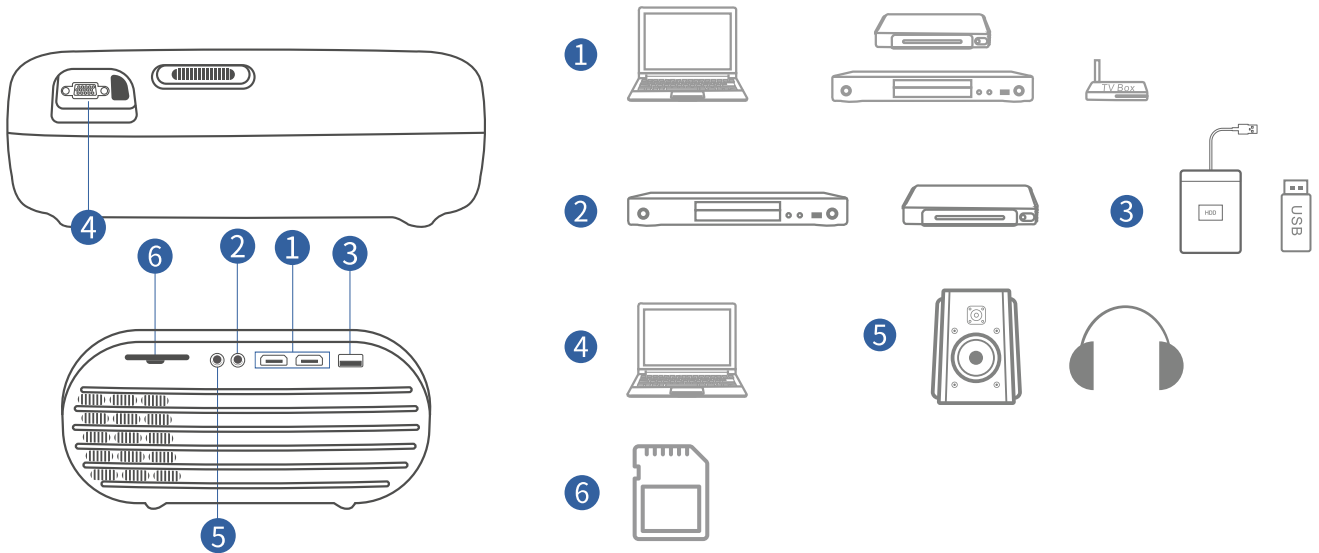

PROJECTION DISTANCE & SIZE

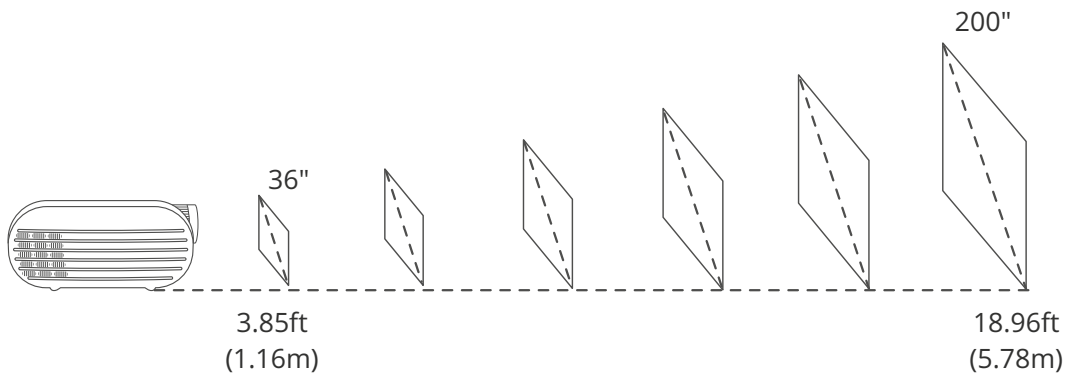

The Recommended projection screen is around 85 inches with a projection distance of around 9.84ft. Ambient darkness will improve the clarity of the projected images.

SPECIFICATION

Display	3200 Lumens	Light Source	LED
Resolution	Native 1280 x 720	Input Signal	800x600/1024x768/1280x800/ 1920x1080
Installation Type	Front / Rear / Ceiling	Aspect Ratio	4:3/16:9
Focus	Manual	Keystone	±15°
Speaker	5W / 4ohm	Power Supply	AC 100-240V, 50/60Hz
Unit Dimensions	235 x 180 x 93mm (9.2 x 7 x 3.6in)	Unit Net Weight	1.3kg (2.86lbs)
Photo Format Supported	BMP/JPG/JPEG/PNG/GIF	Audio Format Supported	MP3/WMA/M4A/AAC/WAV
Video Format Supported	AVI/MP4/DIV/MOV/MKV/ DAT/MPEG/FLV/WMV/VOB/ MPG	Ports	AV x 1/USB Port x1/VGA Port x 1/ SD x 1/Audio Out x1/HDMI In x2

TROUBLESHOOTING GUIDE

1. Blurry Image

*Adjust focus ring / keystone

*Projector and screen / wall must be in effective distance.

2. Remote Unresponsive

*Make sure remote points at IR receiver directly.

*Do not cover IR receiver

*Try a new pair of AAA batteries

3. Mobile Connection

iOS: Genuine lightning to HDMI cable.

Android: Micro USB to HDMI adapter / Type C to HDMI cable.

Wireless Display Adapter: Anycast , Chromecast , Amazon Firestick.

4. Upside Down Images

Go to MENU > PICTURE > PROJECTION MODE to flip the projection image.

5. Home Theater Connection

The Projector can be connected to Home Theater using Audio-out Port available on the projector.

CAUTION



The symbol indicates AC voltage



RECYCLING

This product bears the selective sorting symbol for Waste electrical and electronic equipment (WEEE).