

EVERYCOM X10 PROJECTOR USER MANUAL

Please read manual throughly before using and keep it for future reference.

CONTENTS

Packing Content	01
Function Overview	02
Quick Start	03
Input Source	04
Projector Connection	05
Projection Distance & Size	05
Projection Methods.....	06
Specifications	09
Troubleshooting Guide	10

PACKING CONTENT

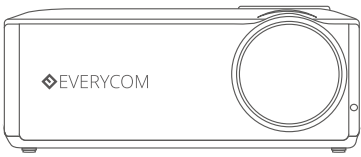

Projector



Remote

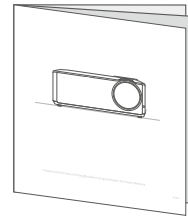

User Manual

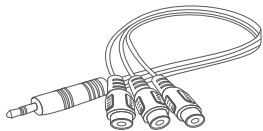

AV Cable

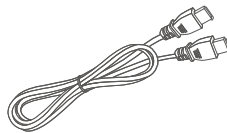

HDMI Cable

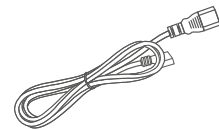

Power Cable

NOTICE

Recommended

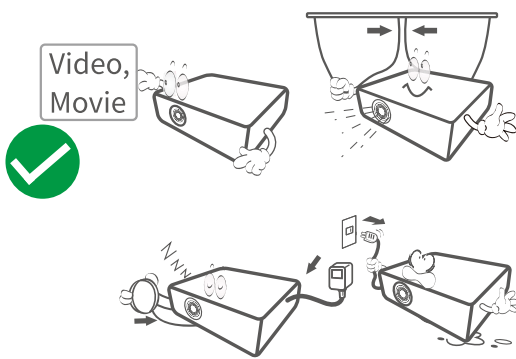

Not Recommended

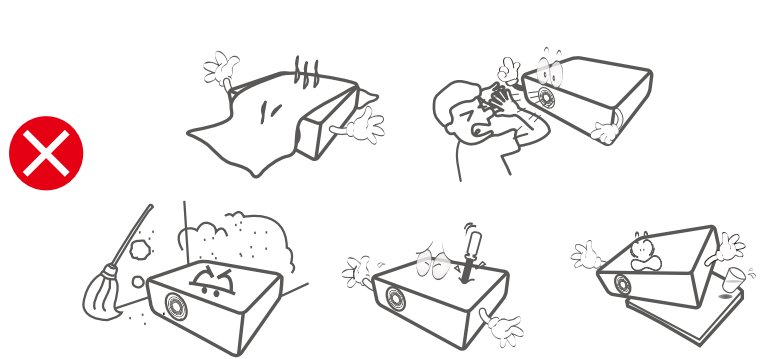

FUNCTION OVERVIEW

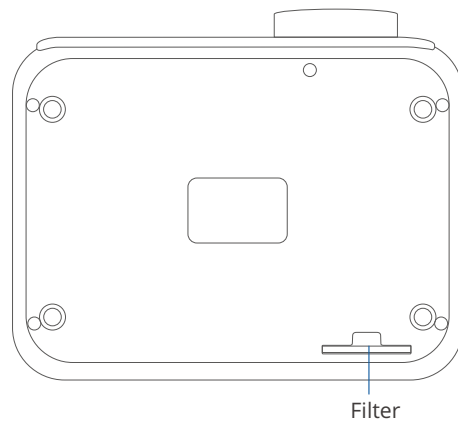
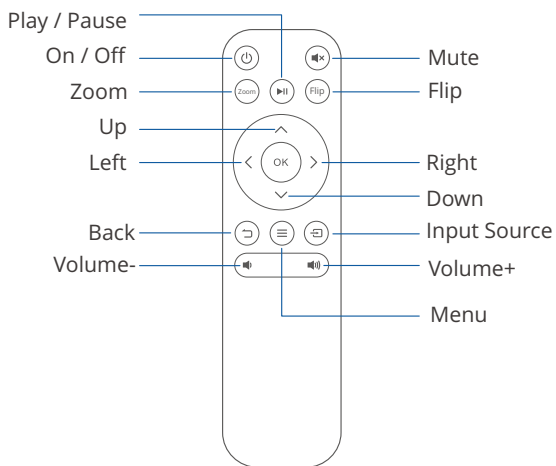
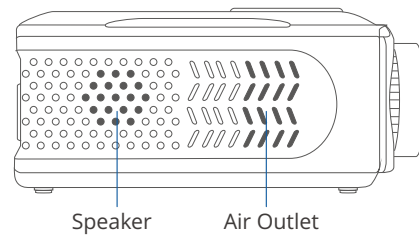
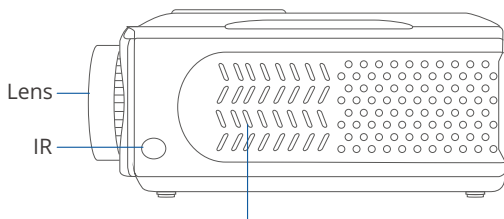
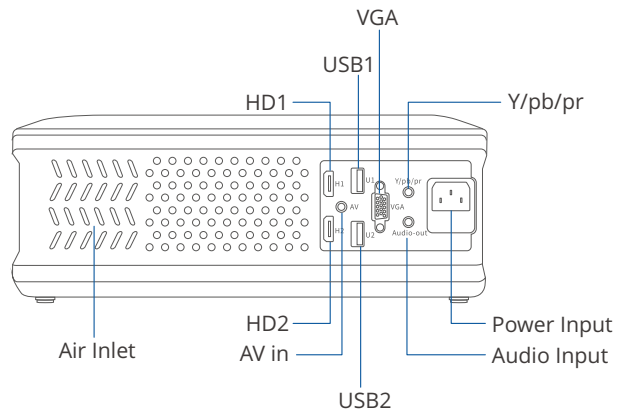
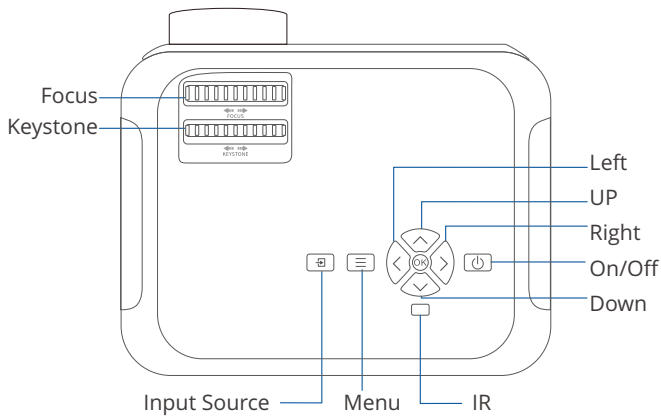

QUICK START

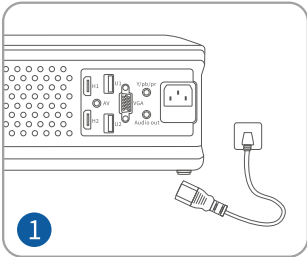

Plug the power cord into an outlet.

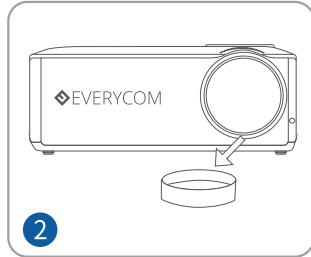

Take off the lens cover

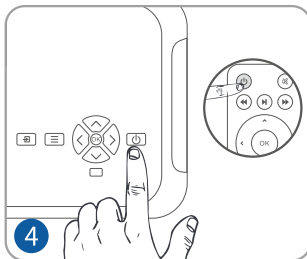

Press the power button to turn on the projector.

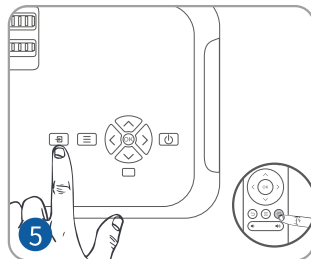

Select the correct input source to project your device.

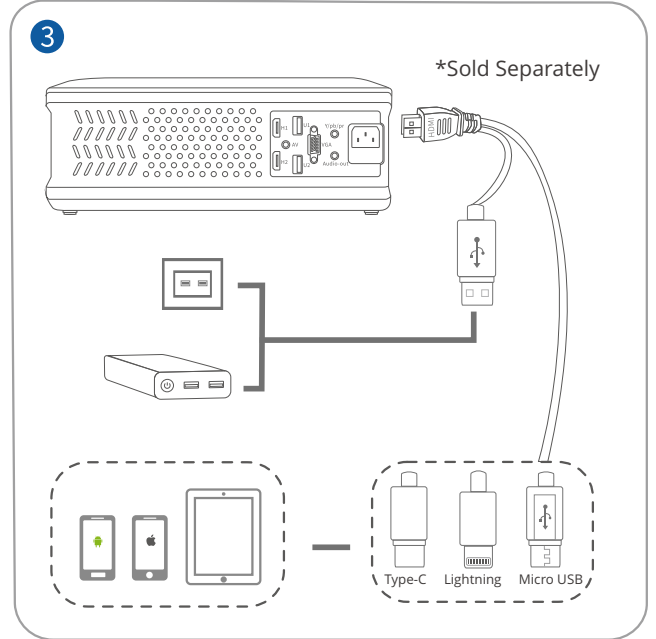

Connect your device to the projector correctly.

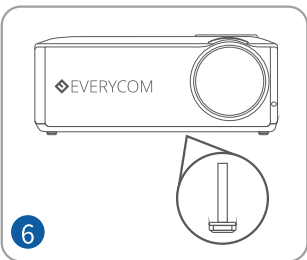

Adjust the kickstand accordingly.

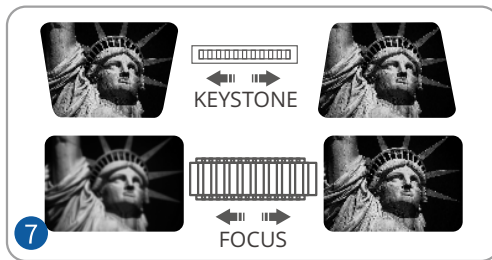

Adjust the keystone and focus ring to get the best image performance.

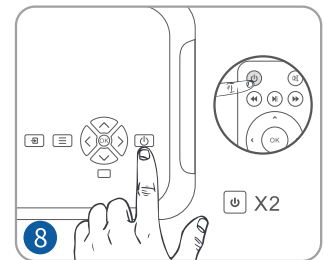

Press the power button twice to turn off the projector

INPUT SOURCE

Press  button on the projector or remote to enter the interface of INPUT SOURCE.

A. VGA Connection

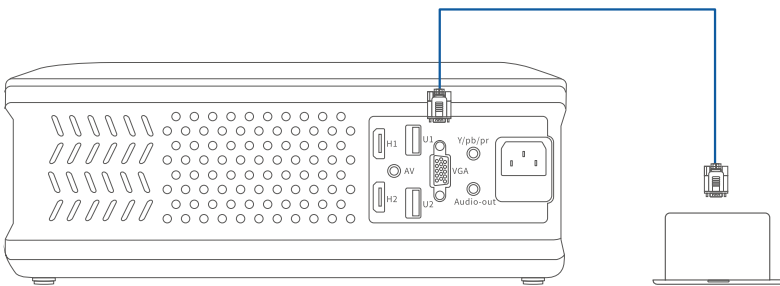

Input Source
AV
YPbPr
HDMI 1
HDMI 2
VGA
USB

B. USB Connection

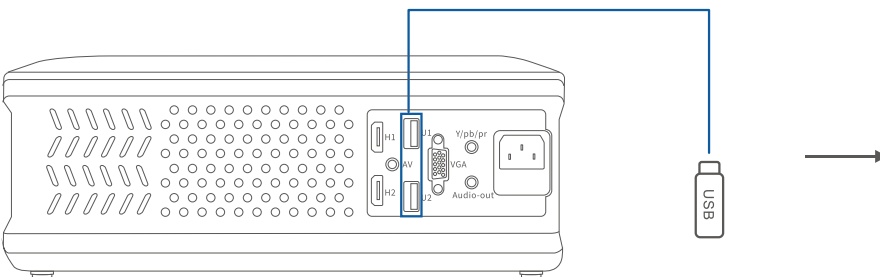

Input Source
AV
YPbPr
HDMI 1
HDMI 2
VGA
USB

C. HDMI Connection

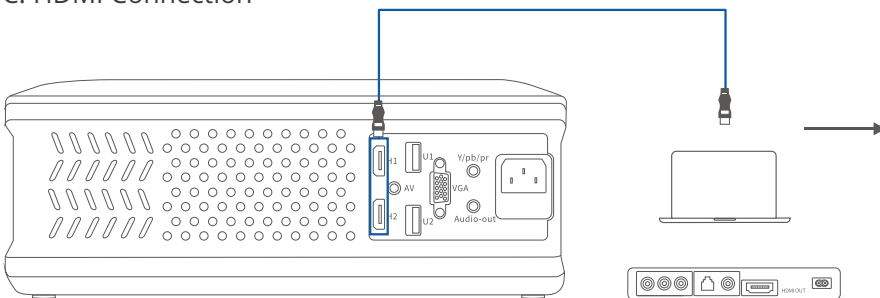

Input Source
AV
YPbPr
HDMI 1
HDMI 2
VGA
USB

PROJECTOR CONNECTION

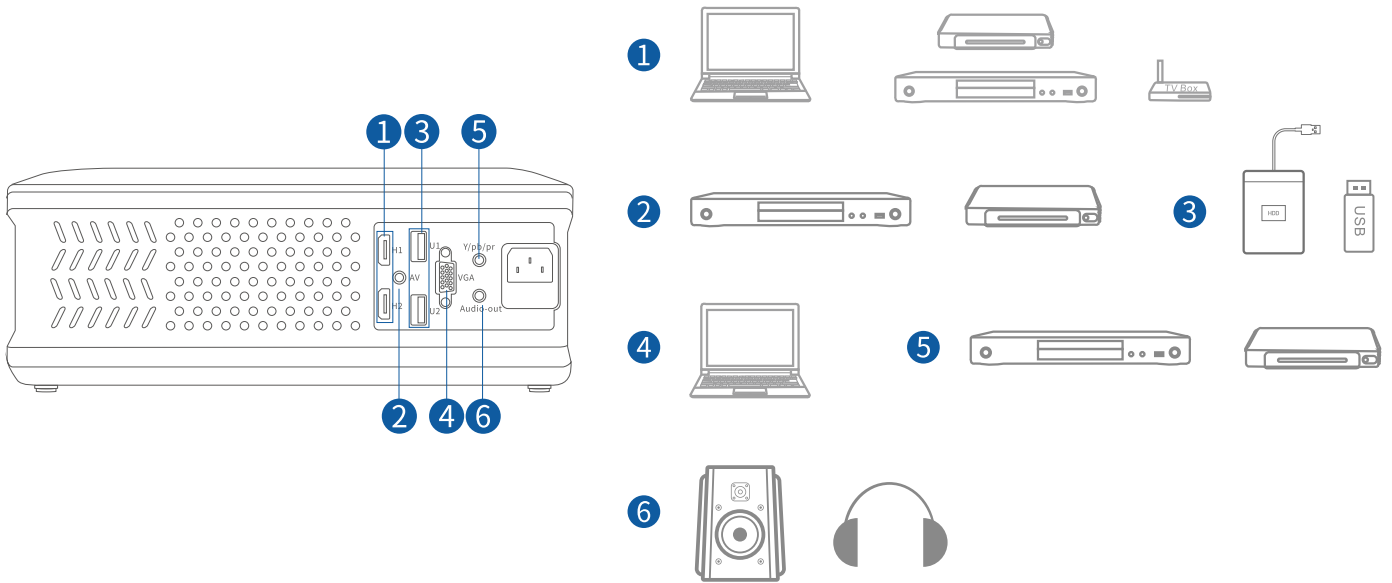

PROJECTION DISTANCE & SIZE

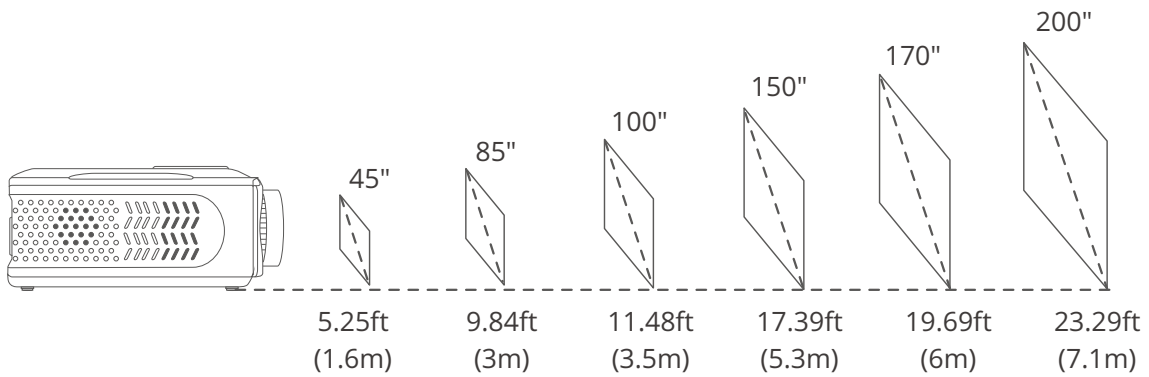

The Recommended projection screen is around 85 inches with a projection distance of around 9.84ft. Ambient darkness will improve the clarity of the projected images.

PROJECTION METHODS

4 Projection methods: Depending on how you place the projector, you may need to change the projection mode so your images will be projected correctly.

1.1 Factory defaults: The Projector is mounted on the same side of the same side of the screen as the viewer

Front Projection

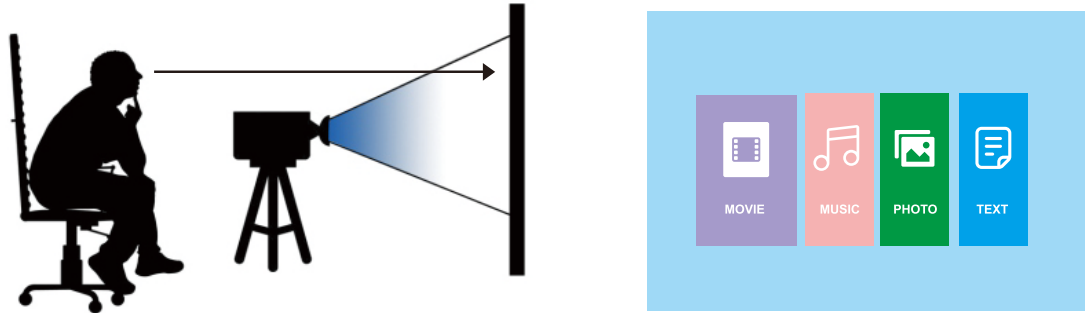

1.2 Rear: The installation position of the projector and the audience are located on the two side of the screen.

You can change the projection mode to rear with the remote control by clicking MENU > SETTING > PROJECTION MODE (Rear on Desk) as the following pictures show.

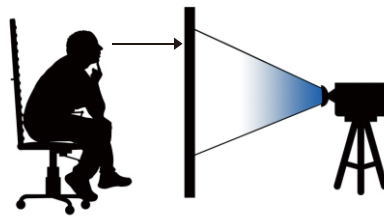

Rear

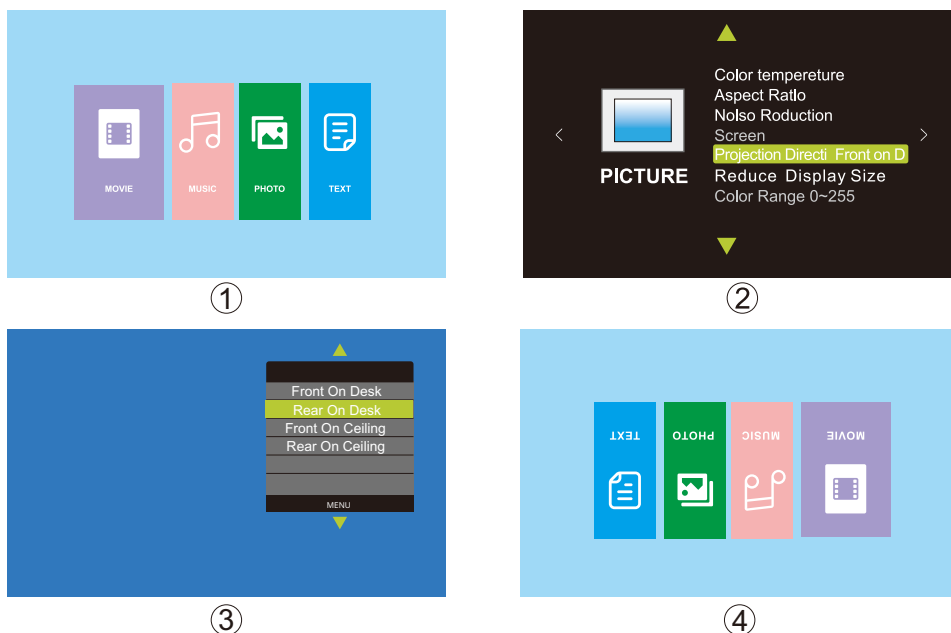

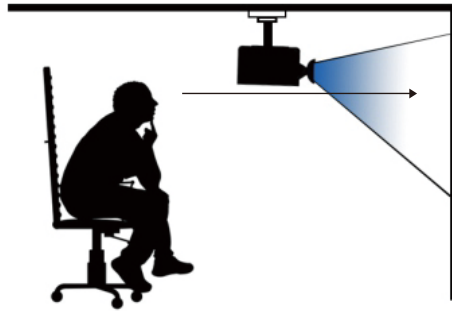

1.3 Front/Ceiling

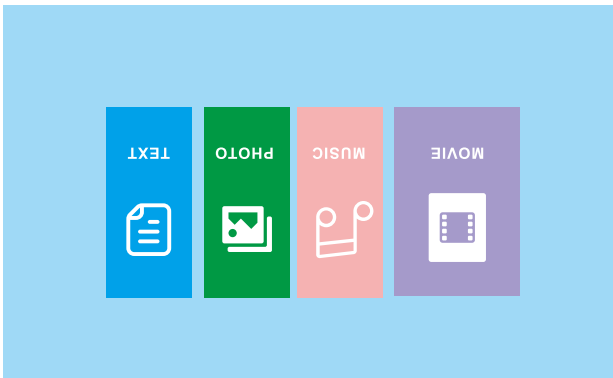

①

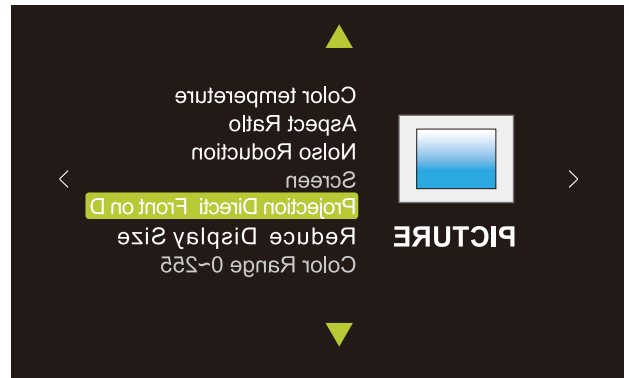

②

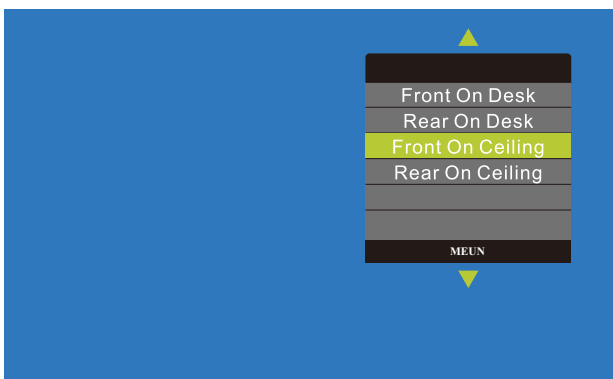

③

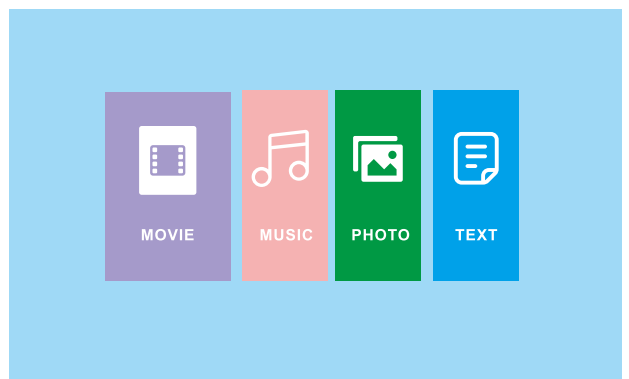

④

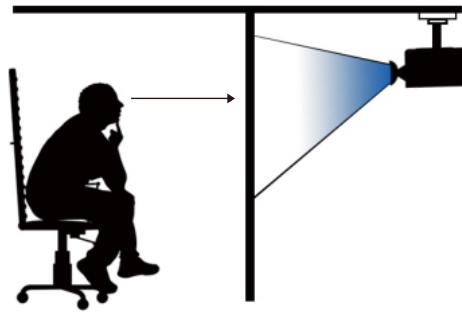

1.4 Front/Ceiling

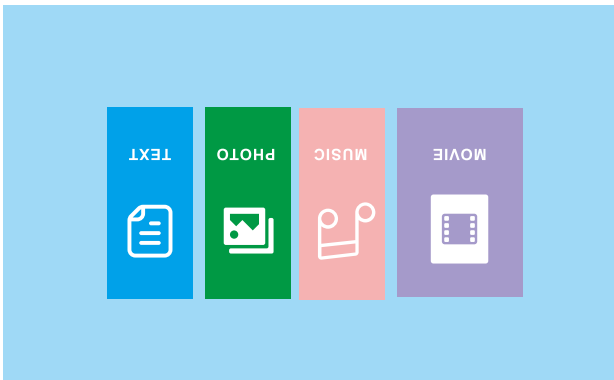

①



②

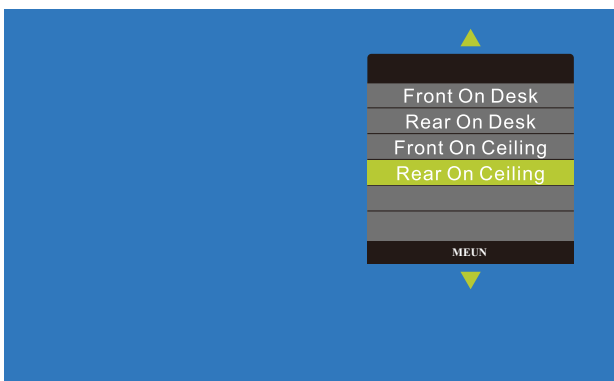

③

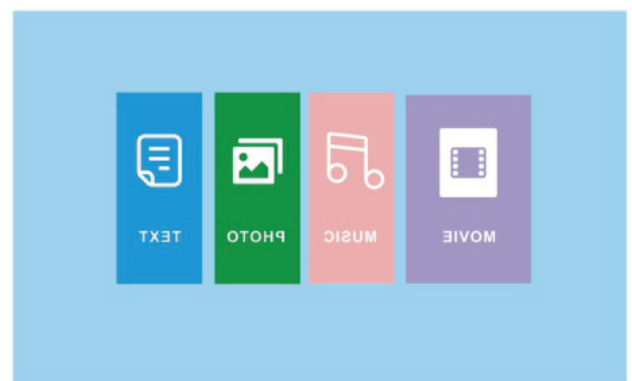

④

SPECIFICATION

Display	5500 Lumens	Light Source	LED
Resolution	Native 1920 x 1080	Input Signal	576i/720P/1080i/1080P
Installation Type	Front / Rear / Ceiling	Aspect Ratio	4:3/16:9/Auto
Focus	Manual	Keystone	±15°
Speaker	3W / 4ohm	Power Supply	AC 100-240V, 50/60Hz
Unit Dimensions	320 x 260 x 120mm (12.6 x 10.2 x 4.7in)	Unit Net Weight	2.56kg (5.6lb)
Photo Format Supported	BMP/JPG/JPEG/PNG/TIF/GIF	Audio Format Supported	MP3/WMA/M4A/AAC/WAV
Video Format Supported	AVI/MP4/DIV/MOV/MKV/ WSF/ASF/FLV/WMV/ASM/ 3GP/3G2/WMV/H264	Ports	Ypbr x 1/USB Port x2/VGA Port x 1/ AV In x 1/Audio Out x1/HDMI In x2
Mounting Screws	M4 Metric	Number Of Screws	4

TROUBLESHOOTING GUIDE

1. Blurry Image

*Adjust focus ring / keystone

*Projector and screen / wall must be in effective distance.

2. Remote Unresponsive

*Make sure remote points at IR receiver directly.

*Do not cover IR receiver

*Try a new pair of AAA batteries

3. Mobile Connection

iOS: Genuine lightning to HDMI cable.

Android: Micro USB to HDMI adapter / Type C to HDMI cable.

Wireless Display Adapter: Anycast , Chromecast , Amazon Firestick.

4. Upside Down Images

Go to MENU > PICTURE > PROJECTION MODE to flip the projection image.

5. Home Theater Connection

The Projector can be connected to Home Theater using Audio-out Port available on the projector.

CAUTION



The symbol indicates AC voltage



RECYCLING

This product bears the selective sorting symbol for Waste electrical and electronic equipment (WEEE).